

Article number: 201055316
Description: E+G Handwheel
GN 949-160-B16-A

Measures

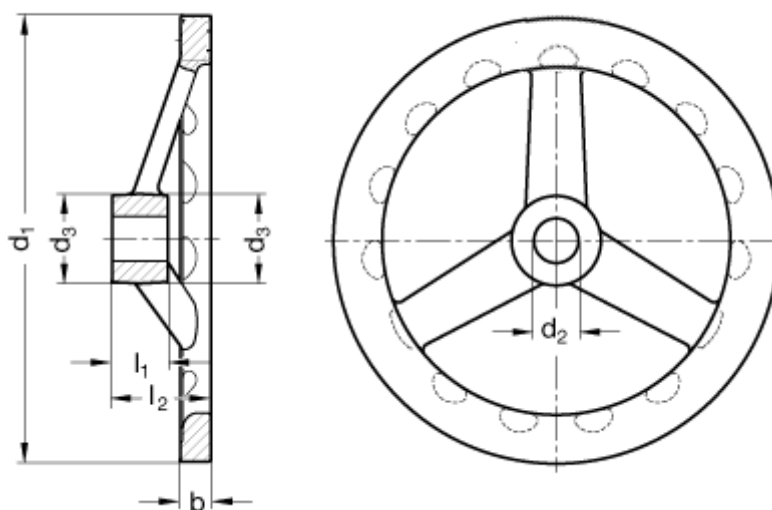

A/F = 11
b = 11
d1 = 160
d2 = 16
d3 = 31
l1 = 20
l2 = 35,5
l3 = 71

Number of spokes = 3